

learning, interpreting, and adapting to the diver's behaviour and physical state



Cognitive Autonomous Diving Buddy

Key facts:

FP7-ICT Cognitive Robotics STREP with 7 partners

EU contribution: €3,7 million

Duration: 36 months, starting 01/01/2014

Coordinator: UNIZG-FER

<http://www.caddy-fp7.eu/>



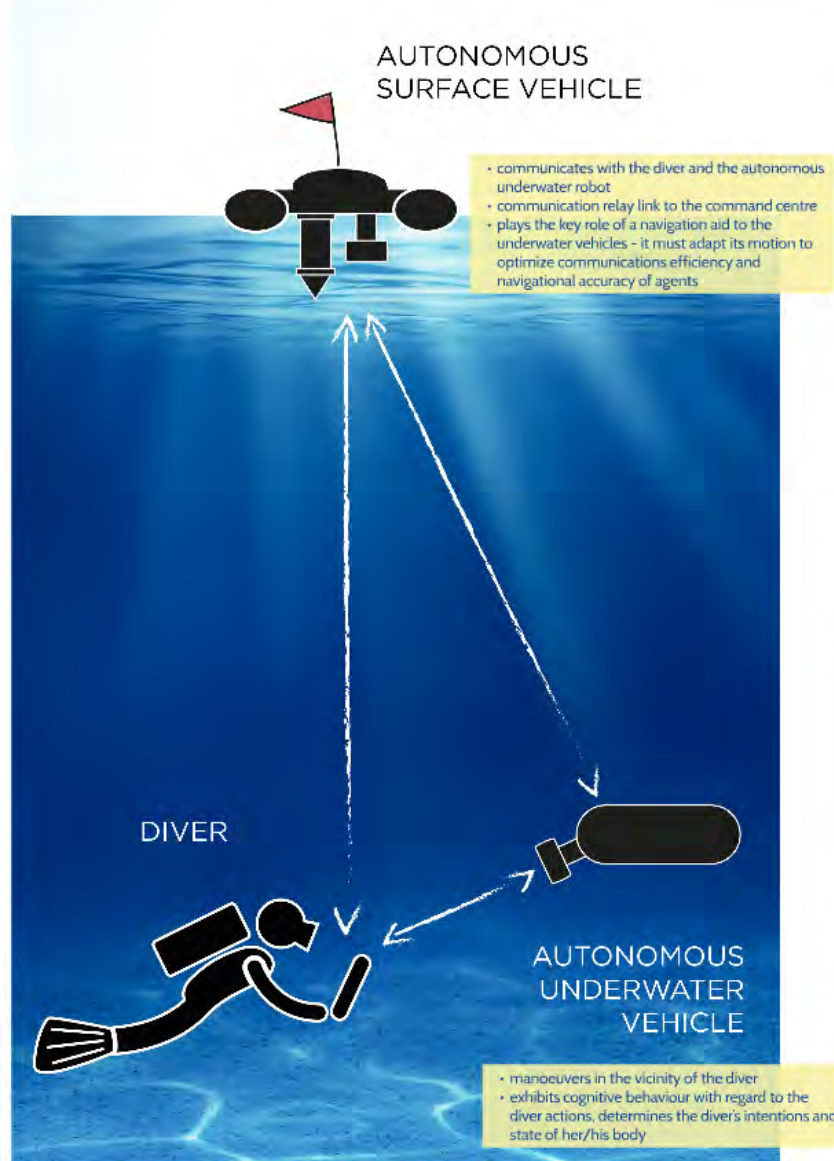

What?

Set up **symbiotic links** between a human **diver** and a set of companion autonomous **robots** (underwater and surface).

How?

By developing a **multicomponent, highly cognitive robotic system** capable of learning, interpreting, and adapting to the diver's behaviour and physical state

**CADDY**



Cognitive Autonomous Diving Buddy

Key facts:

FP7-ICT Cognitive Robotics STREP with 7 partners



# AUTONOMOUS SURFACE VEHICLE



- communicates with the diver and the autonomous underwater robot
- communication relay link to the command centre
- plays the key role of a navigation aid to the underwater vehicles - it must adapt its motion to optimize communications efficiency and navigational accuracy of agents

DIVER



AUTONOMOUS  
UNDERWATER  
VEHICLE



- manoeuvres in the vicinity of the diver
- exhibits cognitive behaviour with regard to the diver actions, determines the diver's intentions and state of her/his body

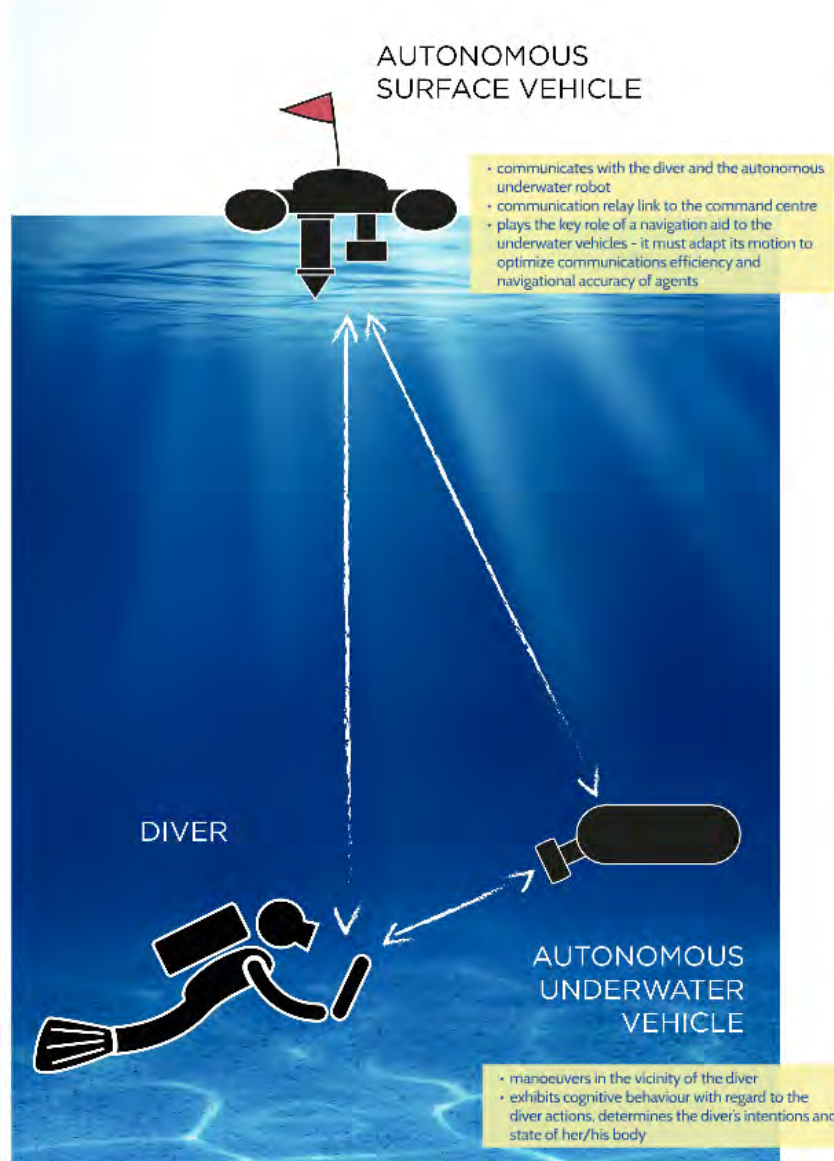

What?

Set up **symbiotic links** between a human **diver** and a set of companion autonomous **robots** (underwater and surface).

How?

By developing a **multicomponent, highly cognitive robotic system** capable of learning, interpreting, and adapting to the diver's behaviour and physical state

**CADDY**



Cognitive Autonomous Diving Buddy

Key facts:

FP7-ICT Cognitive Robotics STREP with 7 partners



# dive guide



- guides (upon request) the diver from one spot to another, along a predefined search path,
- steers the diver safely to an appropriate point at the surface
- acts as an intelligent communication router in situations where the diver loses line-of-sight to the surface vessel.

## dive observer



- observes the diver at all times
- interprets diver's behaviour and symbolic gestures communicated by the diver.
- manoeuvres safely around the diver in order to assume the best viewpoint for observation;

## dive slave



- hovers over a spot indicated by a laser beam and takes photos of the location
- follows the diver
- performs a mosaic of an indicated area,
- illuminates a site from different angles upon request from the diver,
- carries a payload with tools and equipment.



# MedusaS

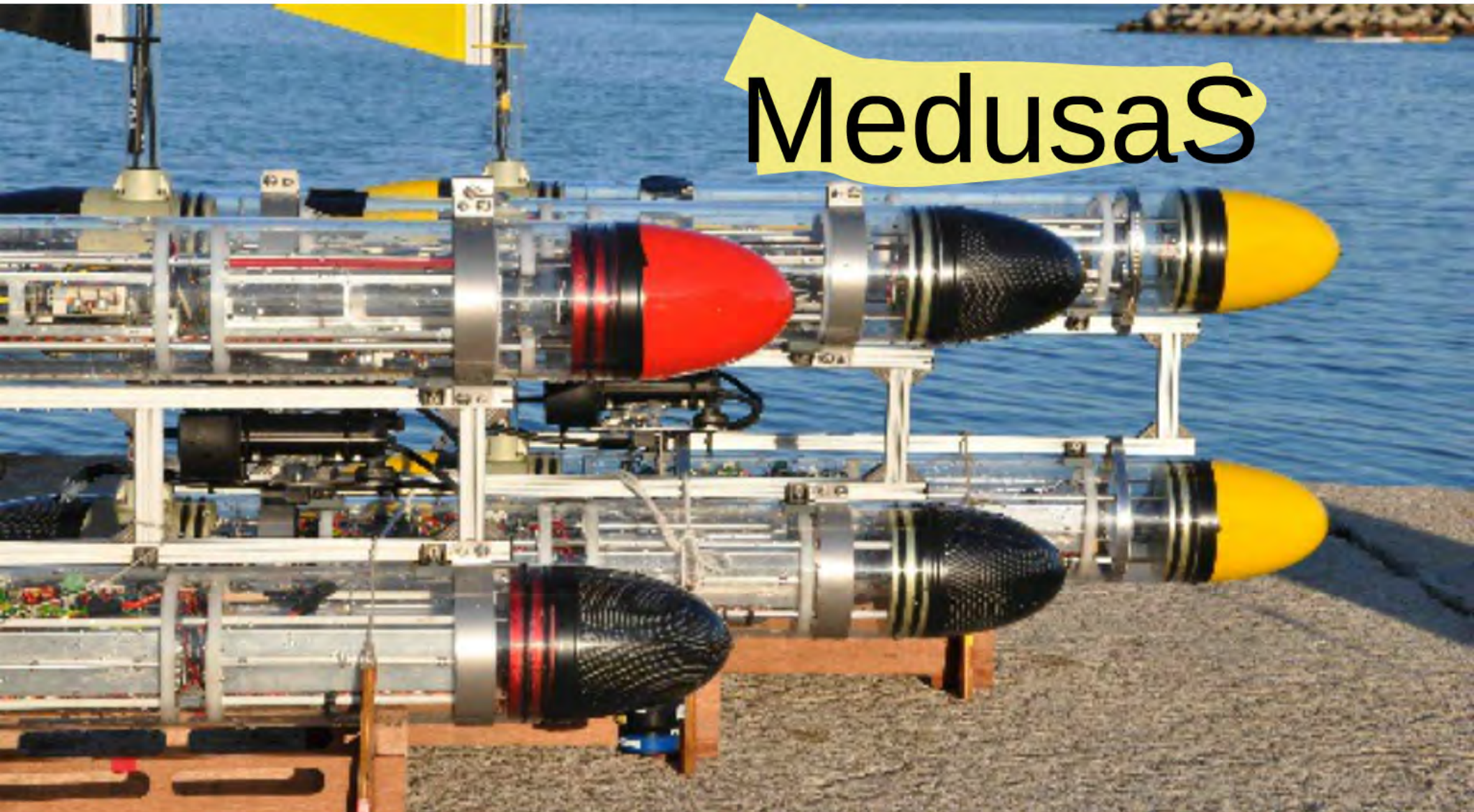

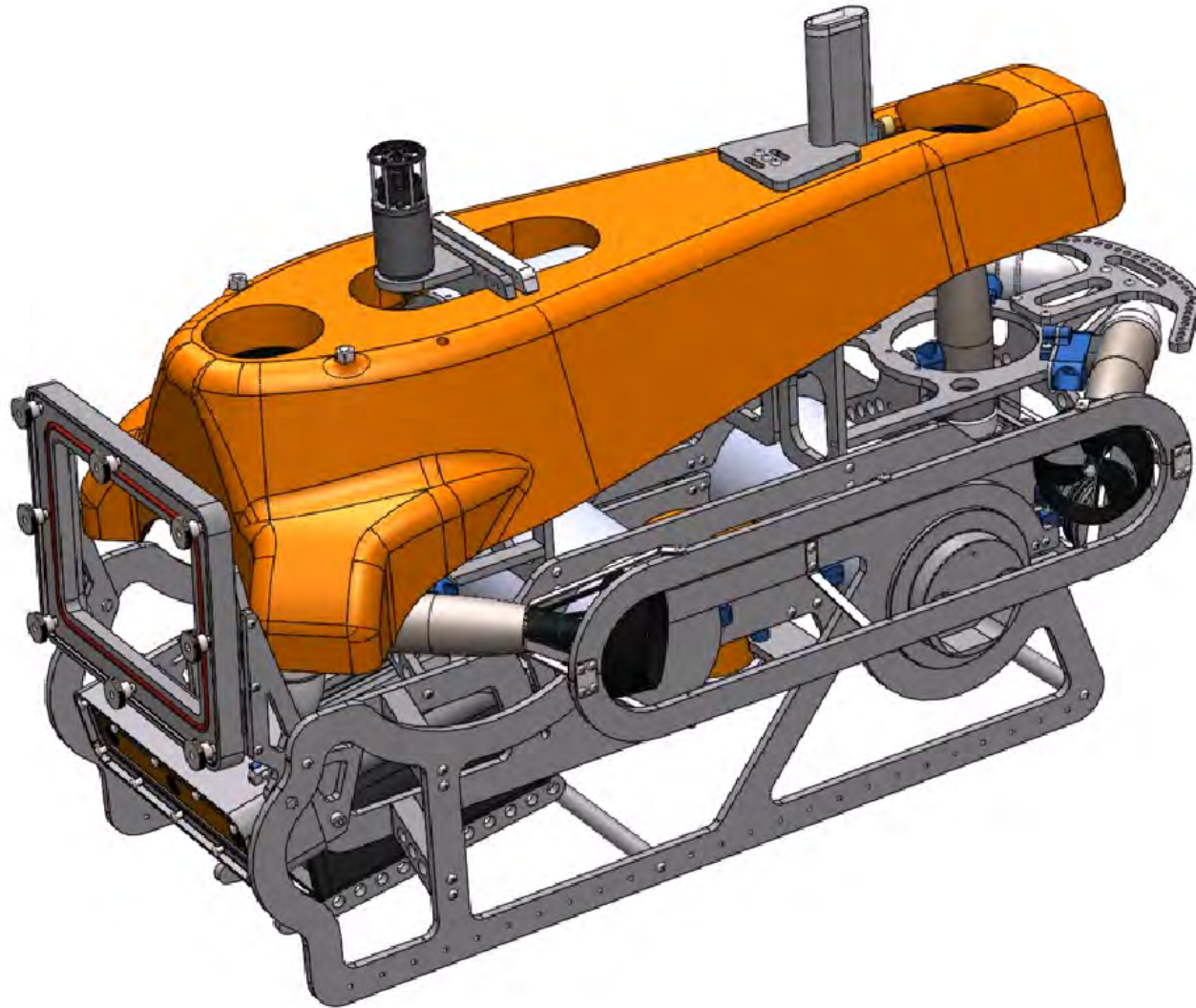

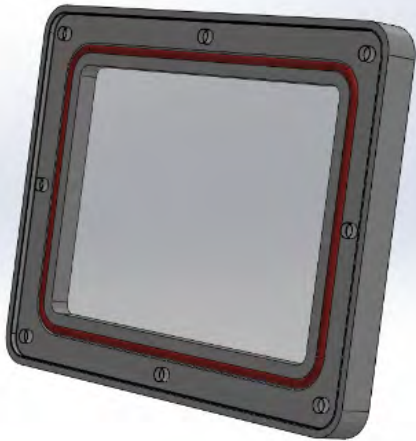

Comms interface with custom and predefined messages



Connected via SeaTrac modem with the surface platform (USBL)



Dive computer

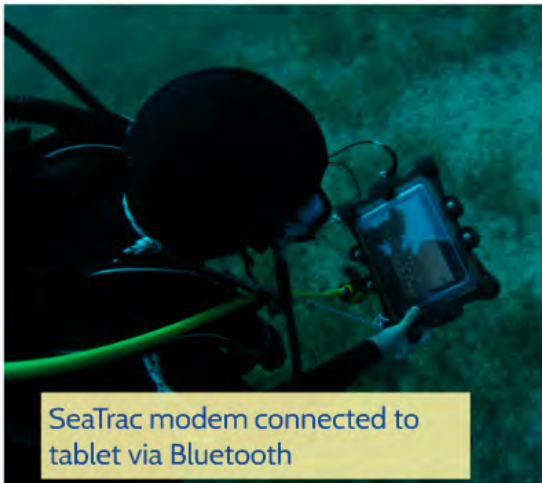

SeaTrac modem connected to tablet via Bluetooth

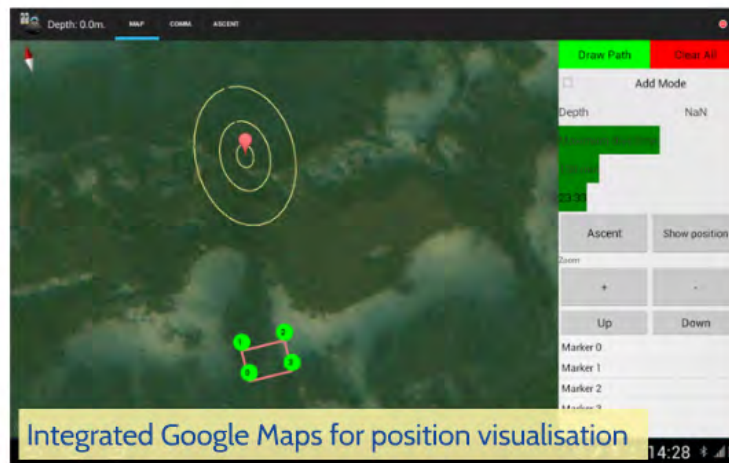

Integrated Google Maps for position visualisation

# Buddy AUV



• GPS and 9-axis IMU





# Final validation trials

10 - 21 October 2016,  
Biograd na Moru, Croatia



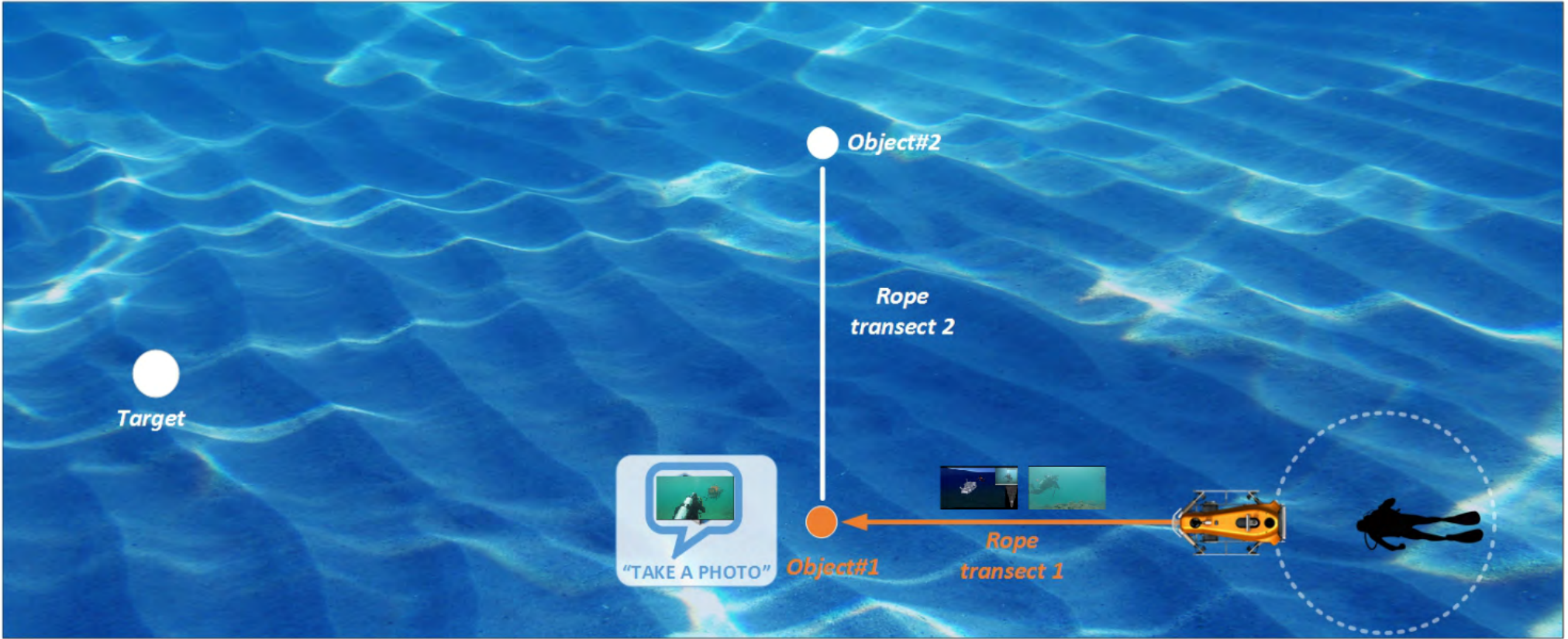
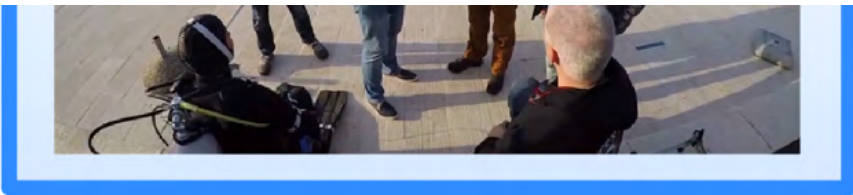

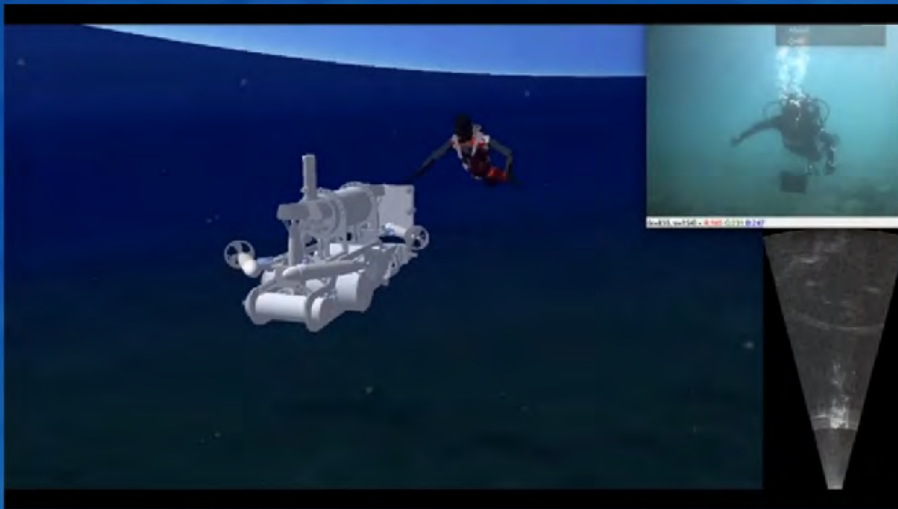

---

*Rope*

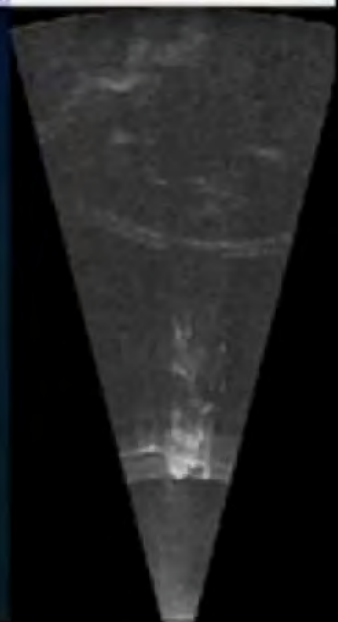
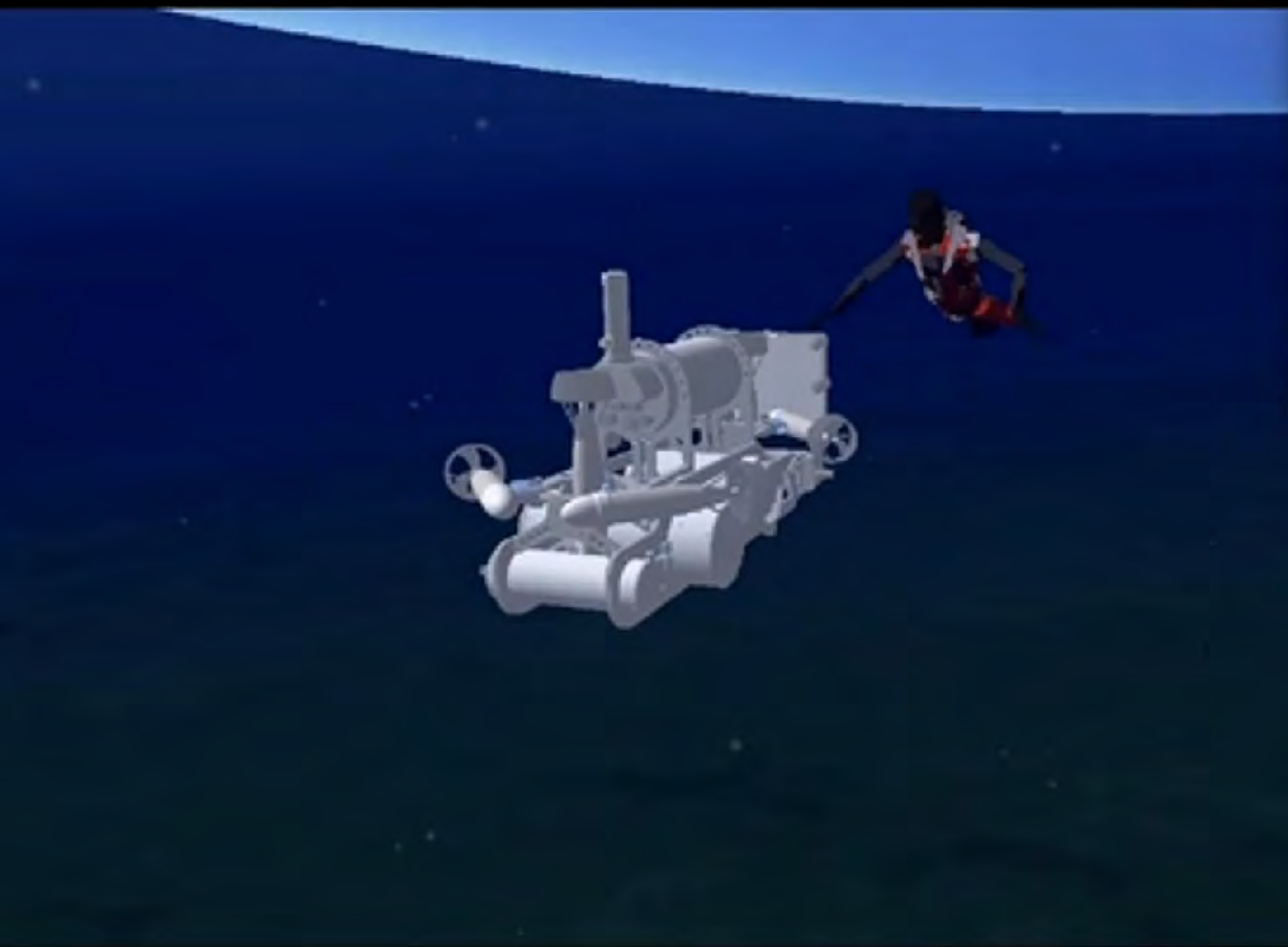



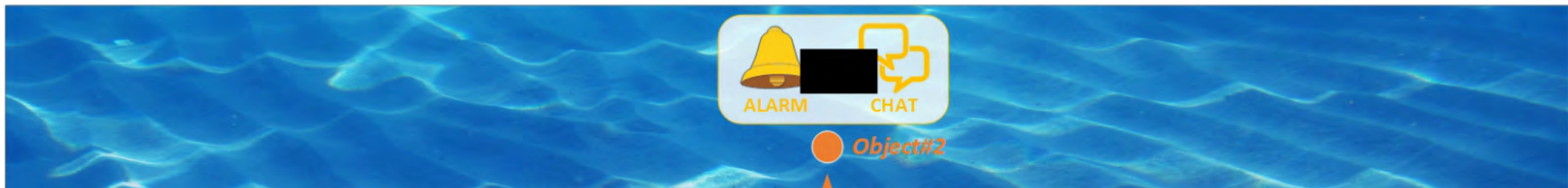
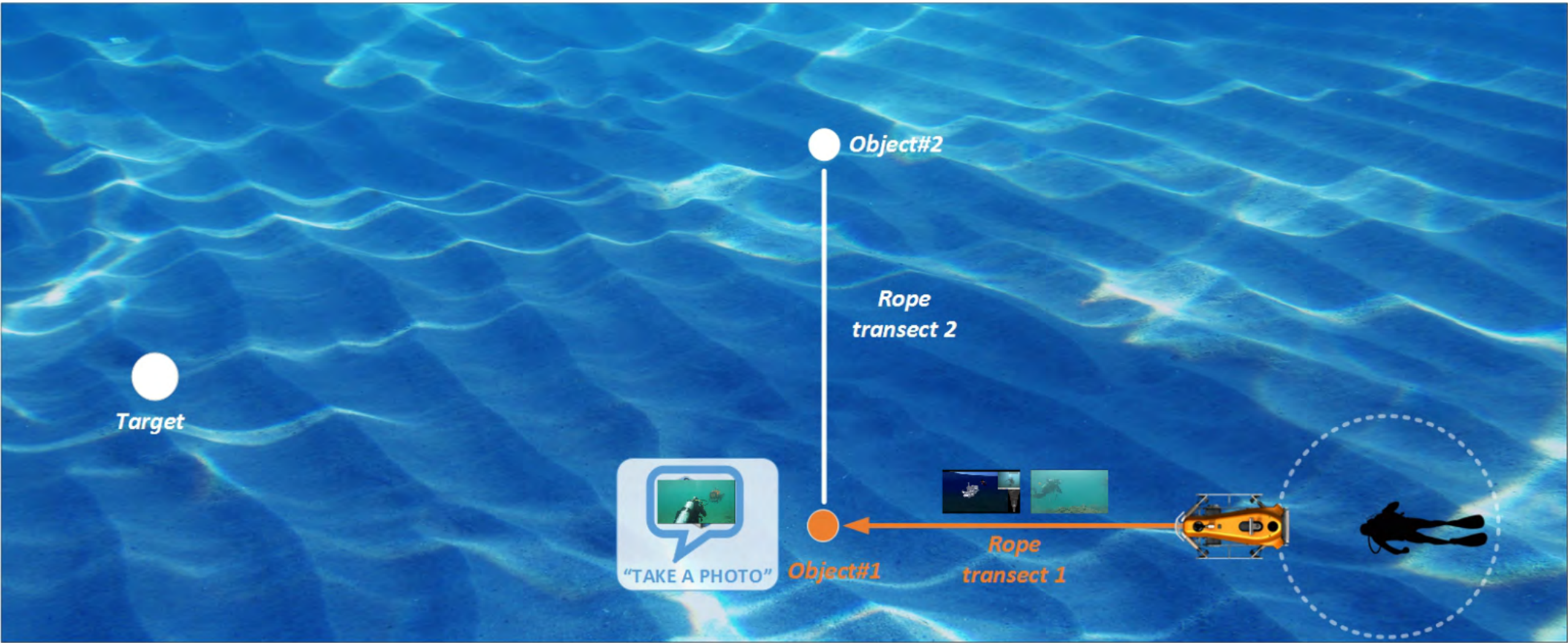



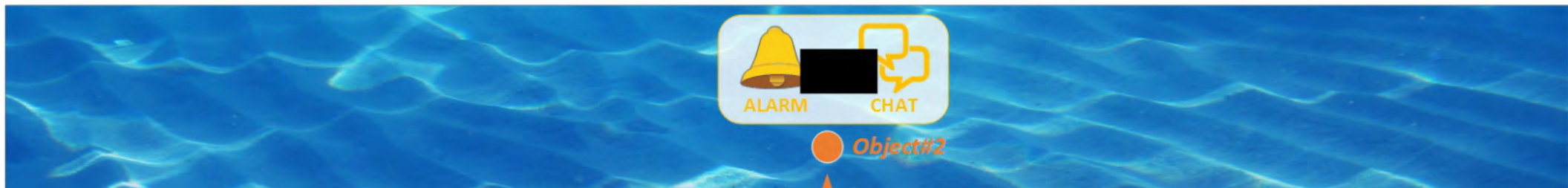
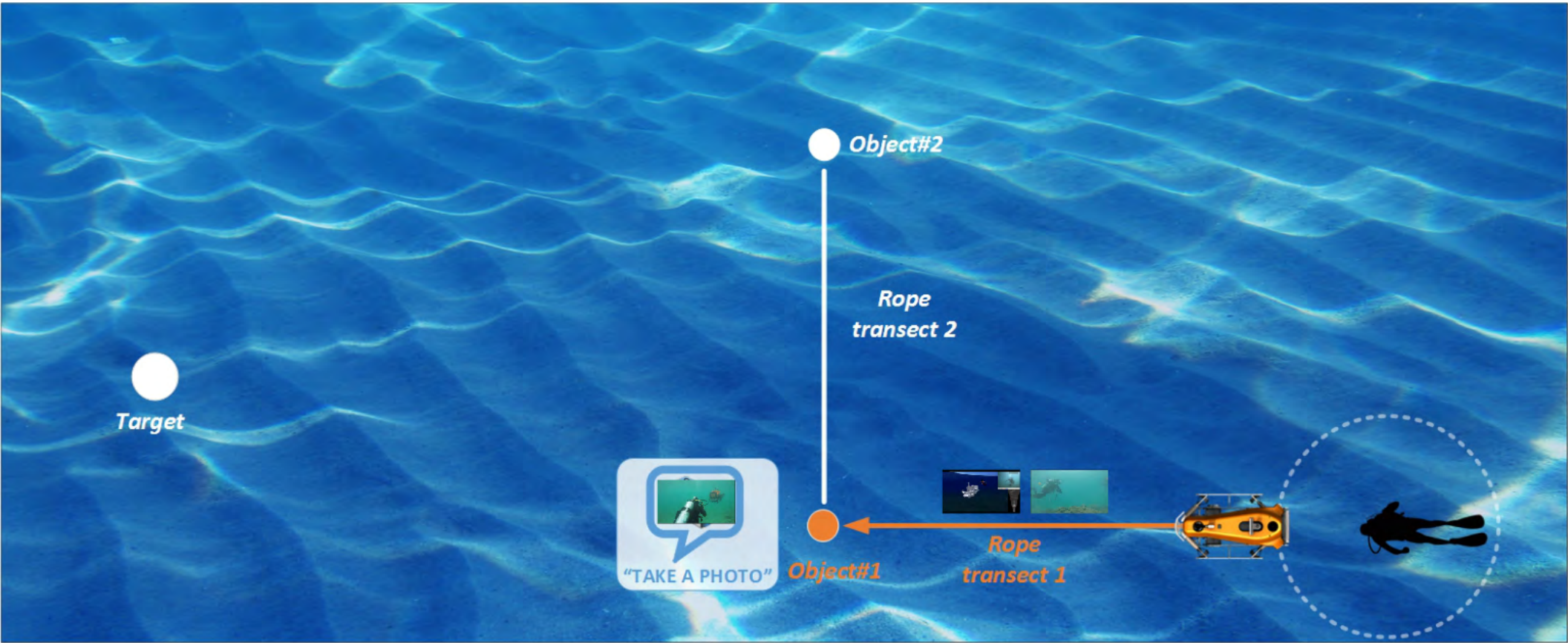

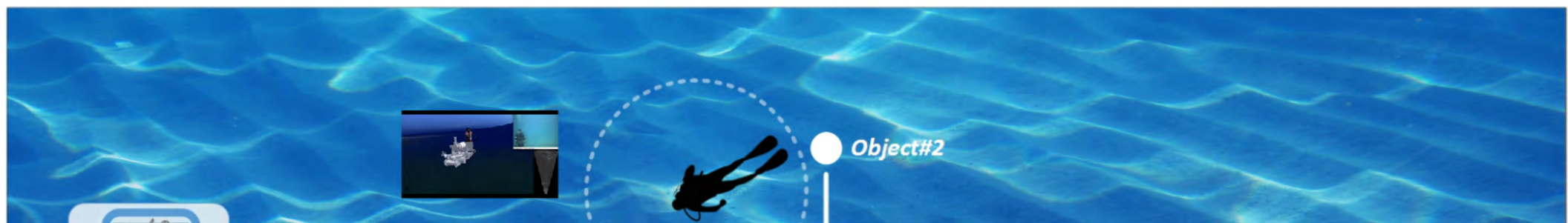
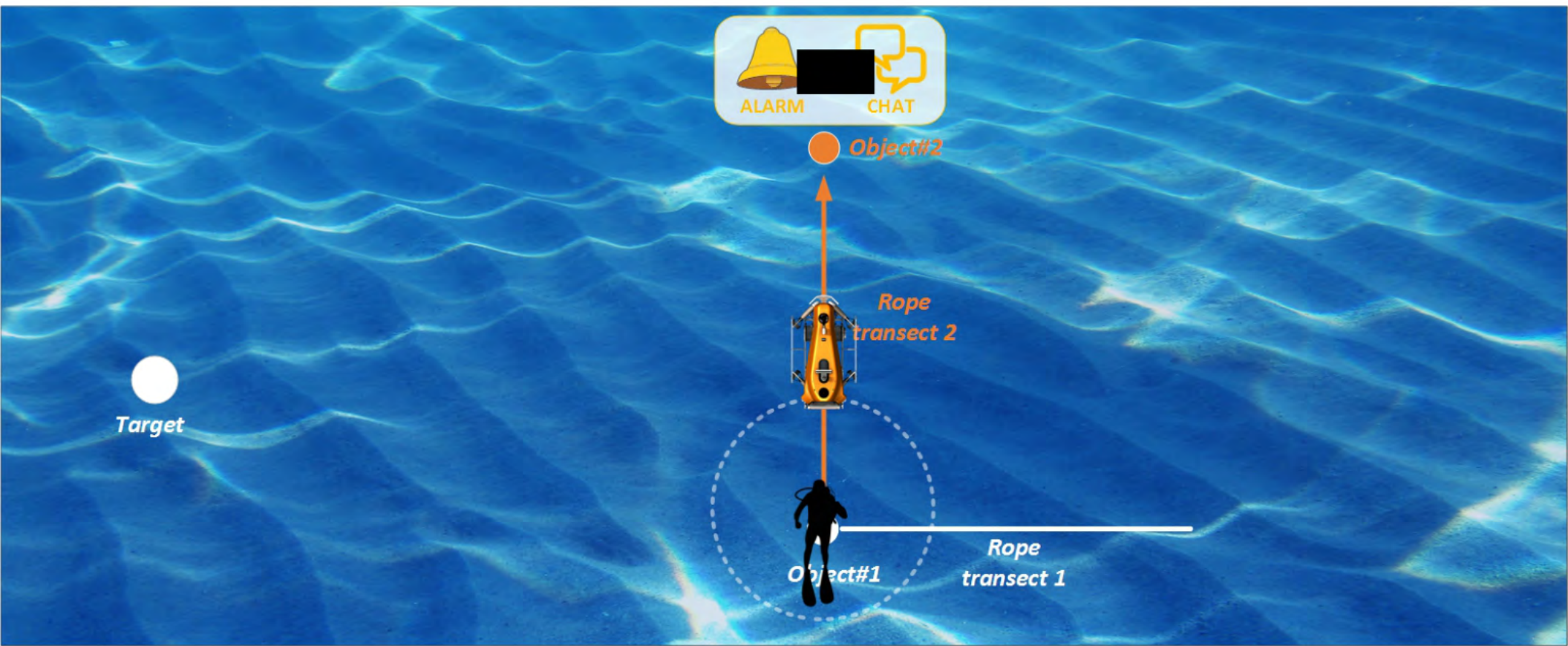
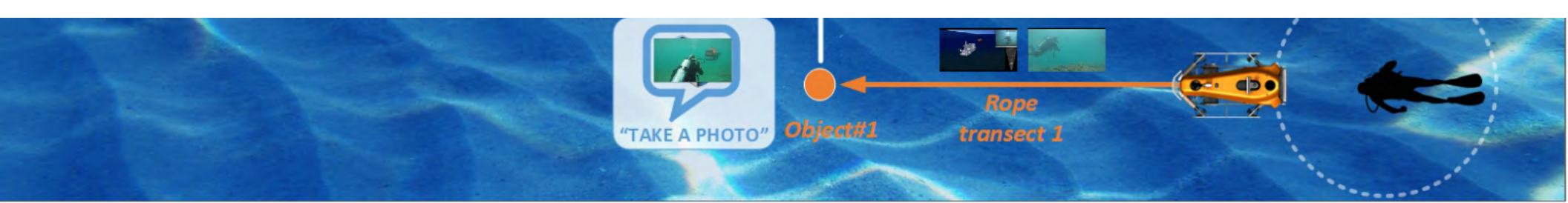

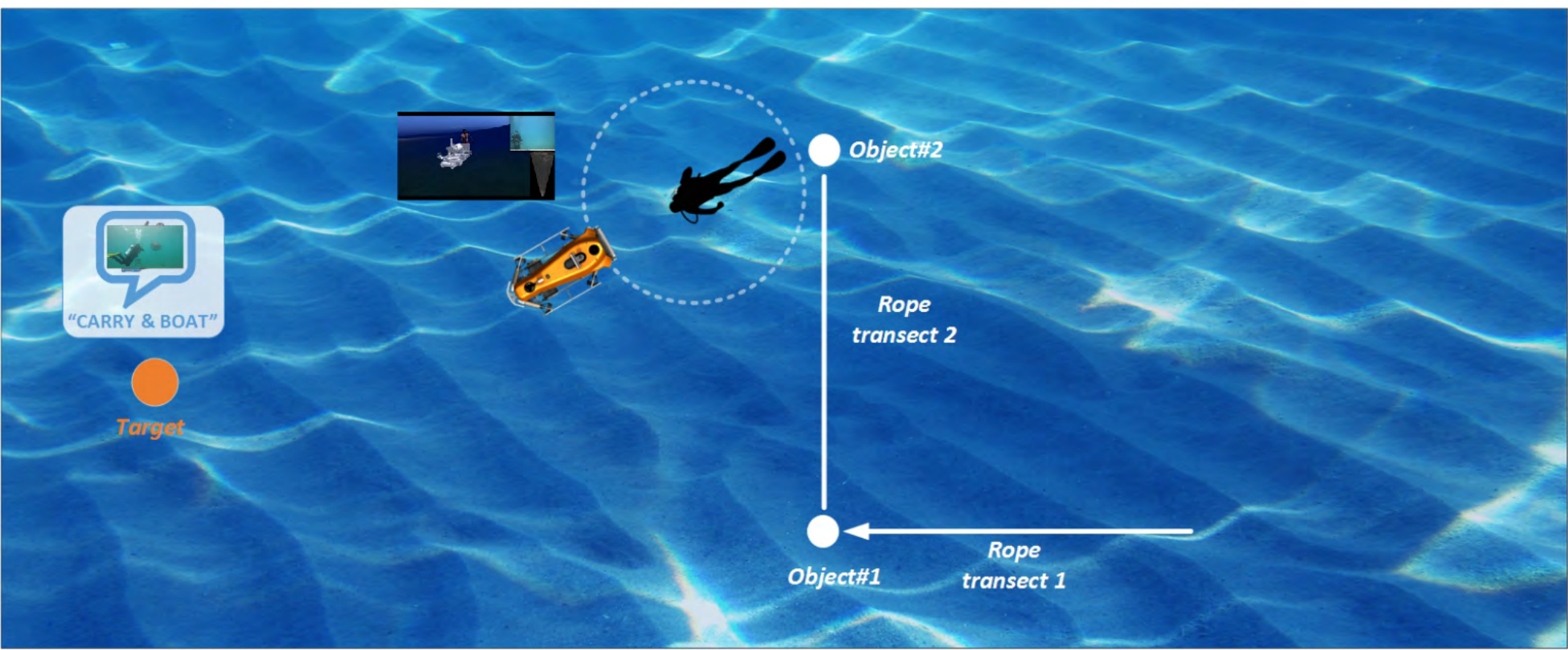



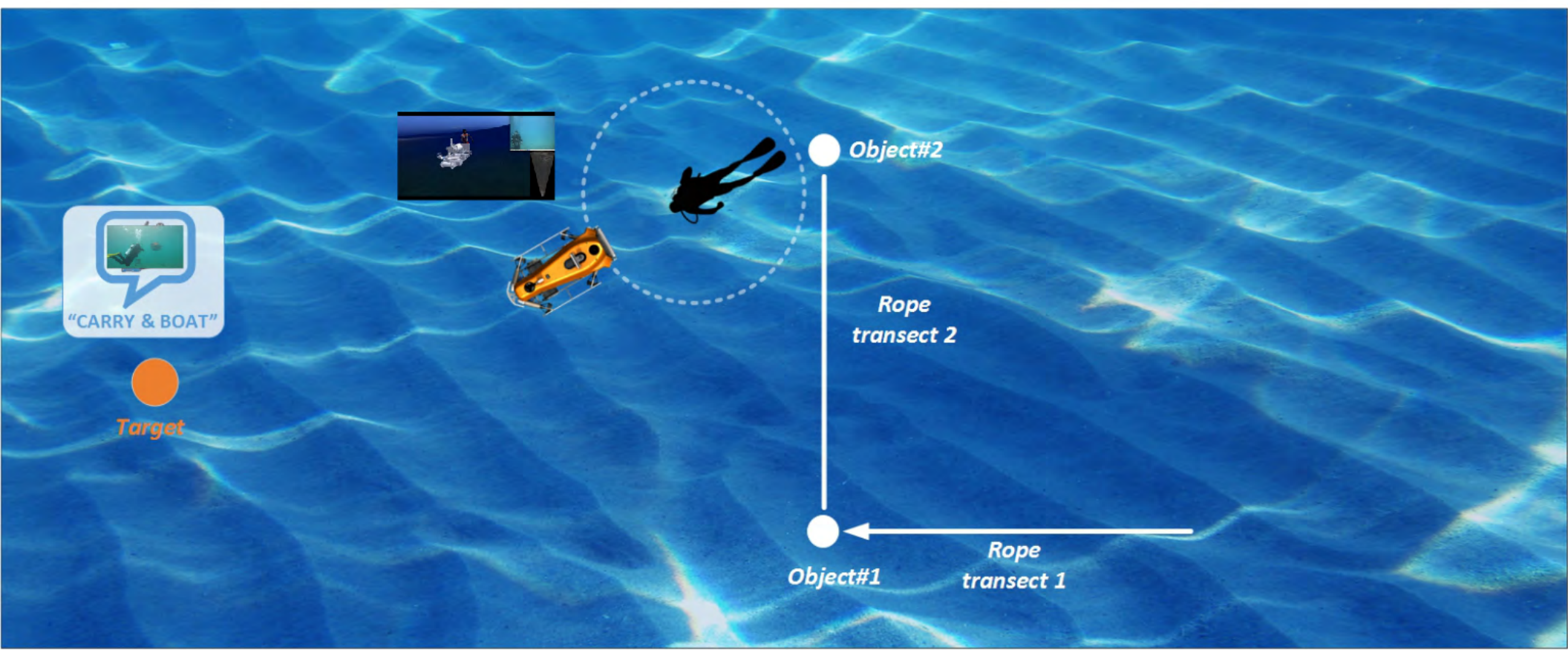
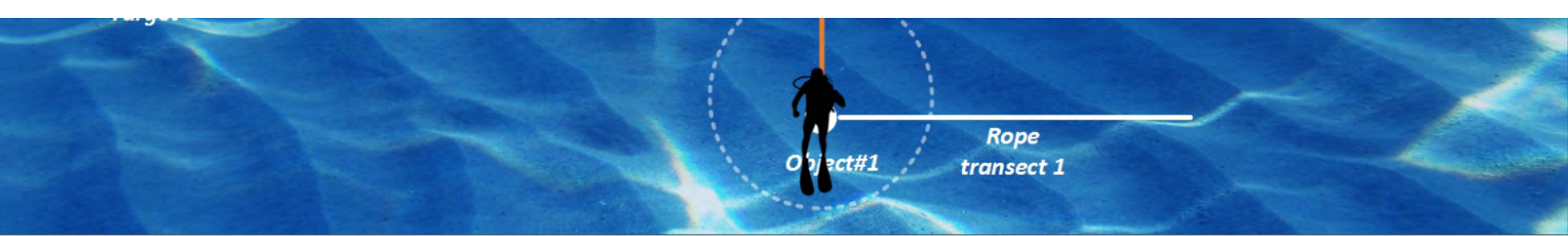

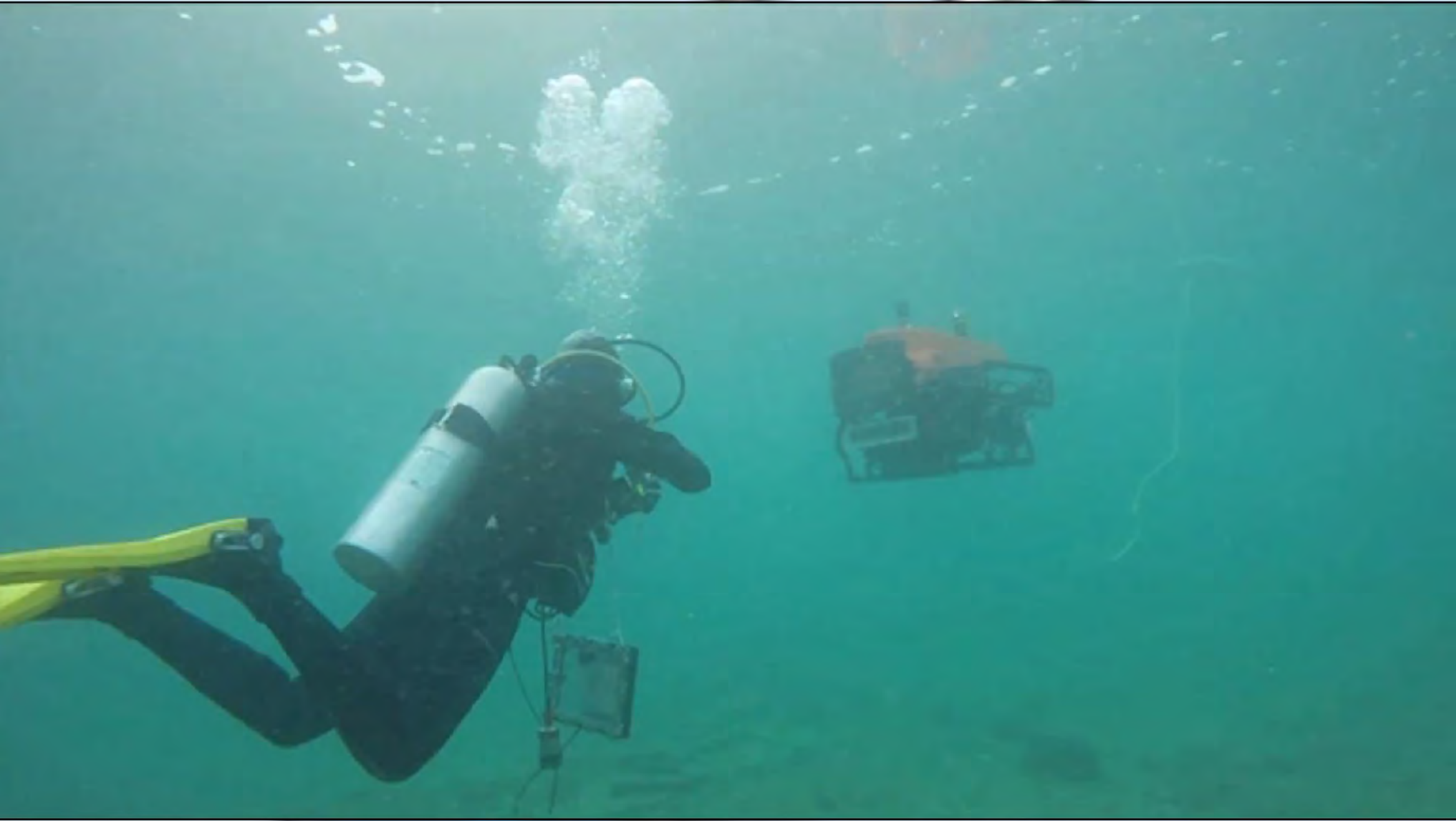



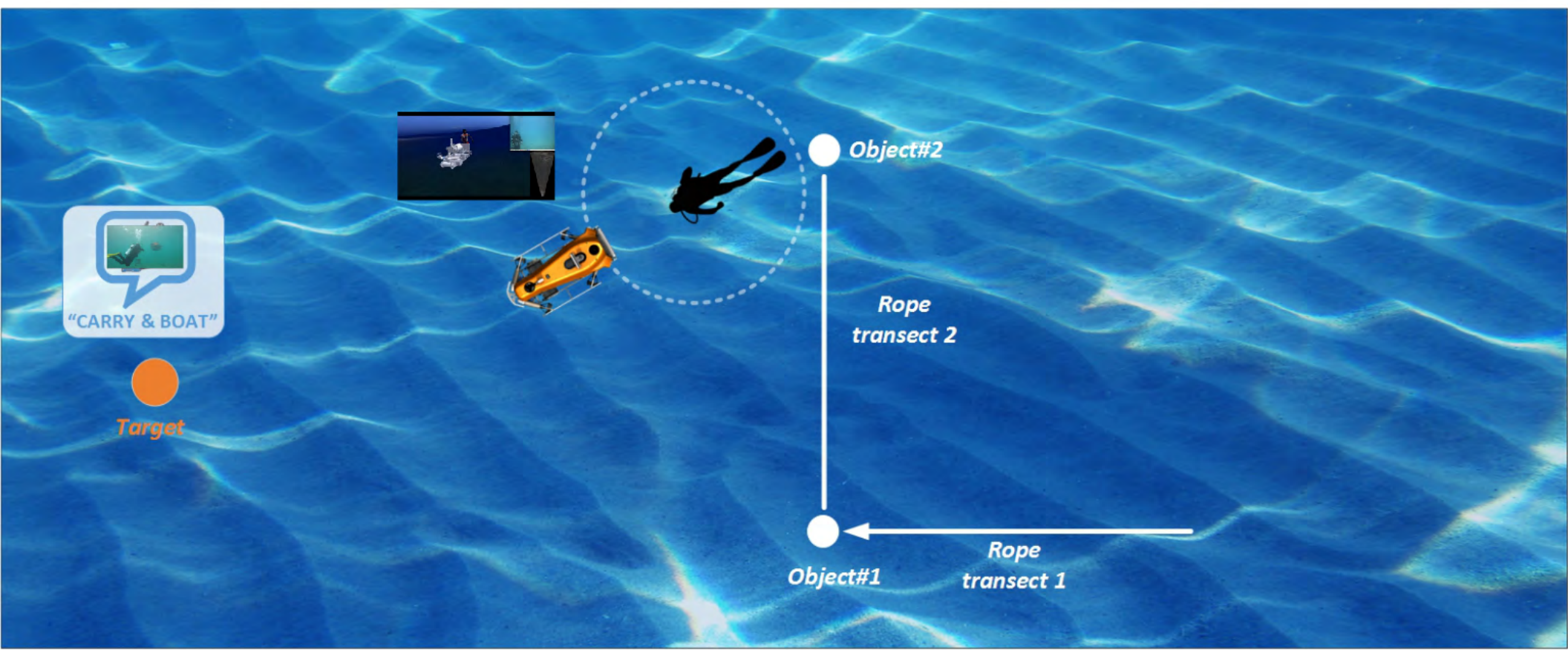



[www.caddy-fp7.eu](http://www.caddy-fp7.eu)



CADDY FP7 project

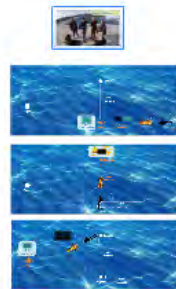

Thank you!